

# SONATA plug-in

Emergency Response Guide

# Contents

1. Identification / recognition	2
2. Immobilization / stabilization / lifting	6
3. Disable direct hazards / safety regulations	7
4. Access to the occupants	12
5. Stored energy / liquid / gases / solids	15
6. In case of fire	18
7. In case of submersion	22
8. Towing / Transportation / storage	24
9. Important additional information	26

# 1. Identification / recognition

## Initial Response: Identify, Immobilize and Disable

The following procedures should be used whenever you are dealing with a SONATA PHEV at an emergency scene. However, all operations should be consistent with your department's standard operating procedures, guidelines, and any applicable laws. When an PHEV is damaged in a crash, the high voltage safety systems may have been compromised and present a potential high voltage electrical shock hazard. Exercise caution and wear appropriate personal protective equipment (PPE) safety gear, including high voltage safety gloves and boots. Remove all metallic jewelry, including watches and rings.

### Identify

The SONATA PHEV is built on a conventional SONATA chassis and therefore the appearance looks very similar to the internal combustion engine model.

Emergency responders should assume that any SONATA you respond to is a Hybrid vehicle and respond to emergency scenarios involving the SONATA PHEV accordingly, exercising extreme care and caution to avoid contact with the high voltage system within the vehicle.



# 1. Identification / recognition

## 1.1 Identifying a HYUNDAI SONATA PHEV

### Engine Compartment and Underside

The SONATA PHEV has a plastic cover with “Plug-in HYBRID” clearly shown on it. Additionally, there are orange colored high-voltage electrical cables in the motor compartment and underside

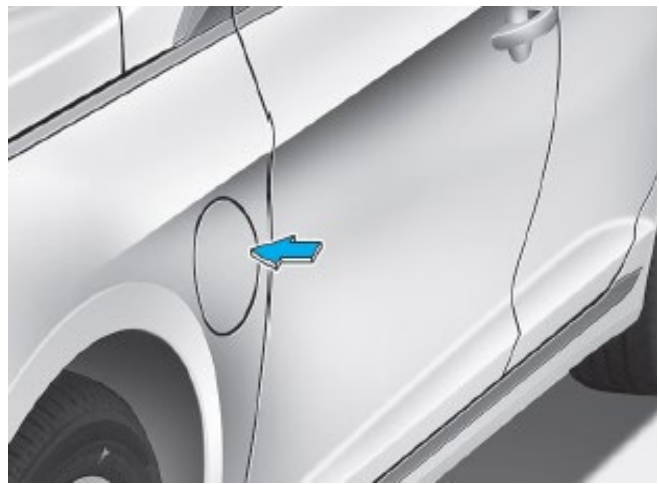

# 1. Identification / recognition

## 1.1 Identifying a HYUNDAI SONATA PHEV

### VIN Label

The VIN (Vehicle Identification Number) identifies an electric car with a “2” displayed in the 8th position, as shown in the below picture.

The VIN can be found:

- 1) Underneath the front passenger seat (or driver seat).
- 2) On the vehicle certification label attached to the driver’s side (or passenger) center pillar.

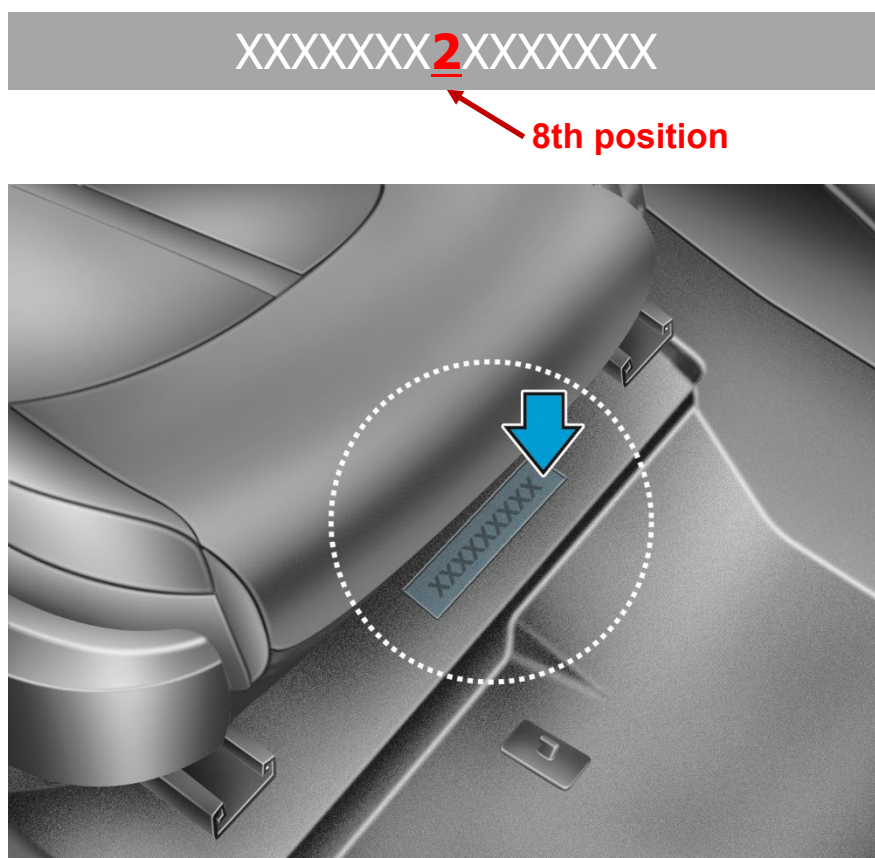

## 2. Immobilization / stabilization / lifting

### 2.1 Immobilization

The next step is to immobilize the vehicle to prevent any accidental movement that can endanger responding emergency personnel or civilians. When the SONATA PHEV is damaged in a crash, the vehicle may appear to be shut off when it is not because the engine emits little to no sound.

When the "READY" mode light is illuminated on the Instrument Panel, the vehicle can move silently using the electric motor. Responders should approach the vehicle from the sides and stay away from the front or rear as they are potential paths for vehicle movement. Be sure to immobilize the vehicle in the following manner.

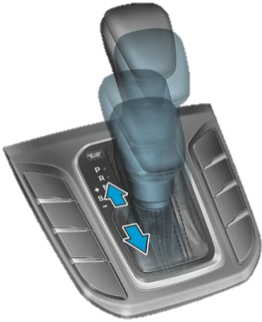

Step on brake pedal to park the vehicle, then position the shift lever in park (P)



Engage Parking Brake



Chock the Wheels

### 2.2 Vehicle Stabilization

Use standard stabilization (lift) points, as shown to the right. Always be sure to connect to a structural member of the vehicle and avoid placing cribbing under high voltage cables, and other areas not normally considered acceptable.



### 3. Disable direct hazards / safety regulations

The final step in the initial response process, conducted after immobilizing the vehicle, is to disable the vehicle, its SRS components and the high voltage electrical system. To prevent current flow through the system, use one of the following procedures to disable the vehicle.

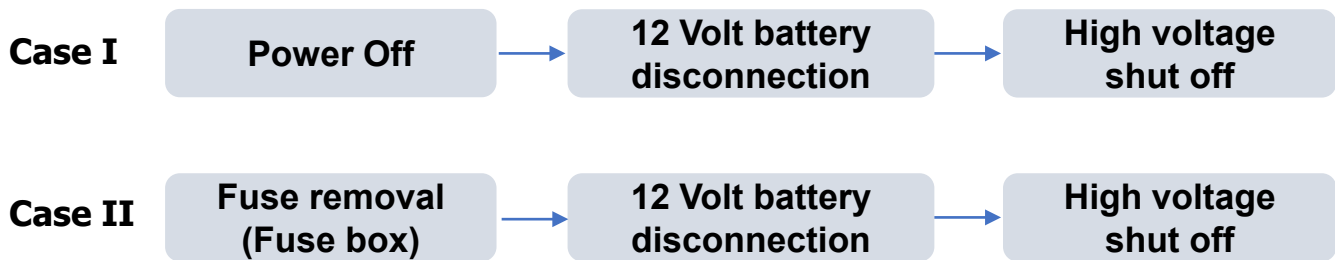

\*In case of the vehicle cannot be disabled using the "power" button.

#### 3.1 Disabling the System – Smart Key System and "POWER" START/STOP Button

1. Confirm the status of the READY light on the instrument panel. If the  READY light is illuminated, the vehicle is ON.
  - a) If the READY light is NOT illuminated, the vehicle is off. Do not push the "POWER" START/STOP button because the vehicle may start (go into READY mode).
  - b) To turn OFF the system, press the 'P' (Park) button, and press the POWER button.

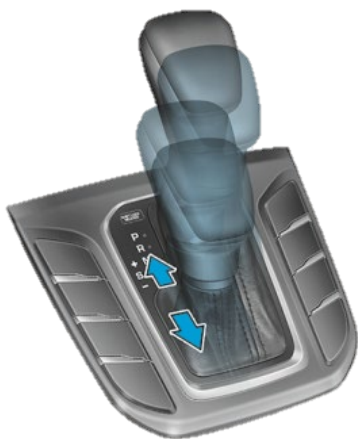

**Position the shift lever in the Park (P)**

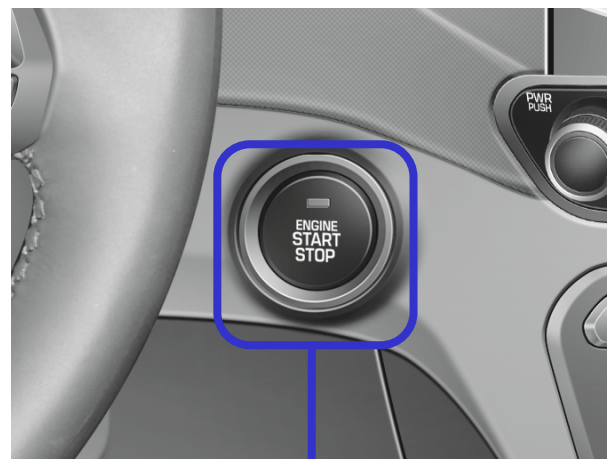

**"POWER" START/STOP Button**

### 3. Disable direct hazards / safety regulations

#### Without depressing the brake pedal

Pressing POWER button	Button Position/LED	Vehicle condition
One time	ACC/ON	Electrical accessories are operational.
Two times	ON/ON	The warning lights can be checked before the vehicle is started.
Three times	OFF	Off

#### While depressing the brake pedal

Pressing POWER button	Button Position/LED	Vehicle condition
One time	START/OFF	Ready to drive

2. If necessary, lower the windows, unlock the doors and open the tail gate as required, before disconnecting the 12 Volt battery. Once the 12 Volt battery is disconnected, power controls will not operate. (Refer to below "4." for 12 Volt battery disconnection)
3. Before disconnecting the 12 Volt battery, remove the Smart Key at least 2 meters away from the vehicle to prevent accidental restart.
4. Disconnect the 12 Volt auxiliary battery Negative(-) cable (B), located in the trunk.

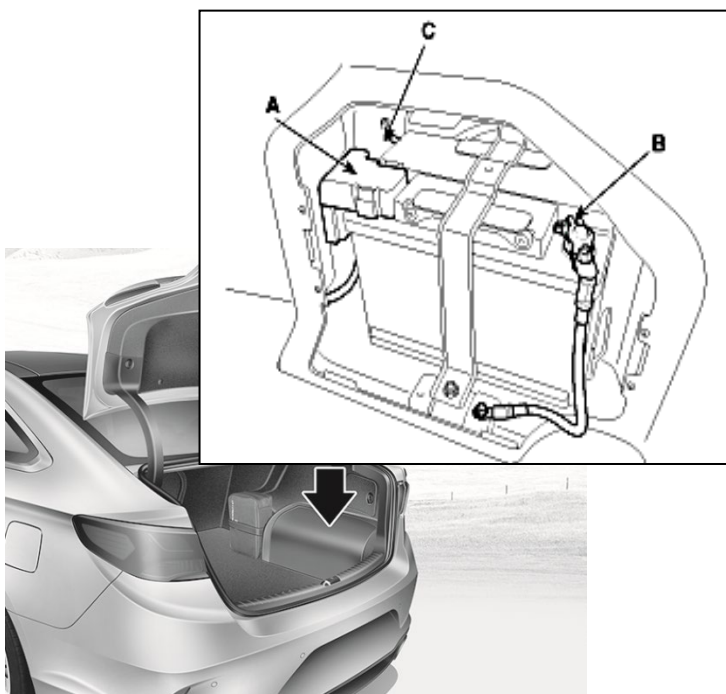



### 3. Disable direct hazards / safety regulations

5. Use the following procedure to remove the Service Disconnect Plug and disable the high voltage battery:

a) Remove the installation bolts (A), and then remove the safety plug cover (B).

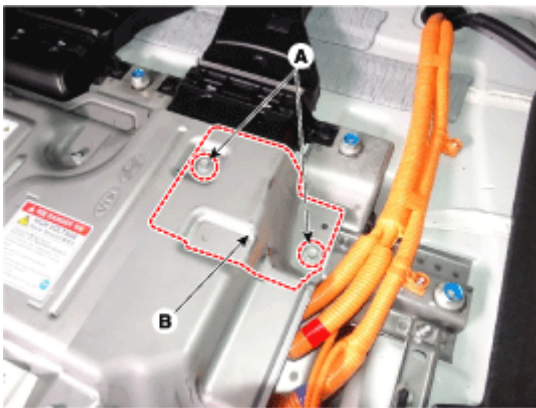

b) Remove the Service Disconnect Plug (C) using the following procedure :

A: Unlock → B: Release → C: Remove

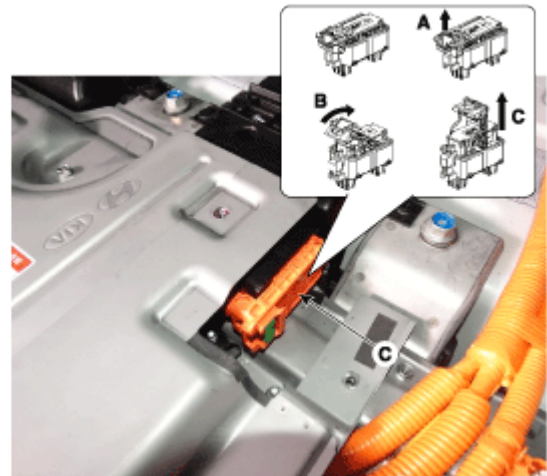

#### **⚠ WARNING** Electrocutation Risk!

- Before engaging in emergency response procedures, ensure the vehicle is disabled and wait for more than 5 minutes to allow the capacitor in the high voltage system to discharge to avoid electrocution.
- Exposed cables or wires may be visible inside or outside the vehicle. To prevent injury or death due to electrical shock, never touch the wires or cables before disabling the system, to prevent injury or death due to electrical shock.

Failure to follow any of these instructions may result in serious injury or death by electrocution.

#### **⚠ WARNING** Explosive Risk!

- SRS components may remain powered and active for up to 3 minutes after the 12 Volt electrical system is shut off or disabled. Disconnect the battery cable and wait for at least 3 minutes before beginning work.

Failure to follow any of these instructions may result in serious injury or death from accidental deployment of the airbag system.

## 3. Disable direct hazards / safety regulations

### 3.2 Disabling the System – IG (Ignition) Fuse Removal

1. Open the hood.

2. Remove the engine room fuse box cover.

3. In the event the vehicle cannot be disabled using the “Power” START/STOP Button, pull the IG1, IG2 fuses or relays from the engine compartment room fuse box. If the IG fuses cannot be located, pull out all the fuses and relays in the fuse box.

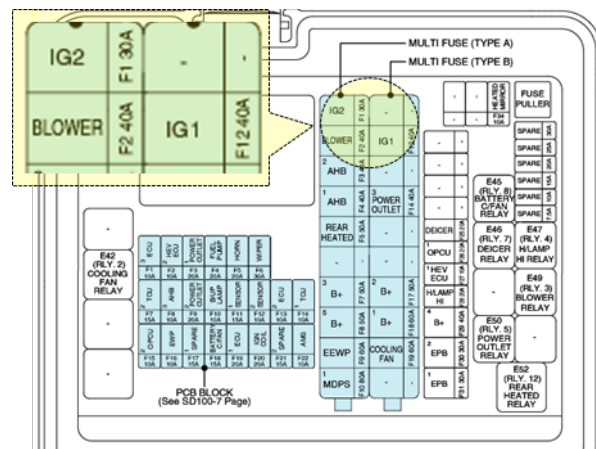
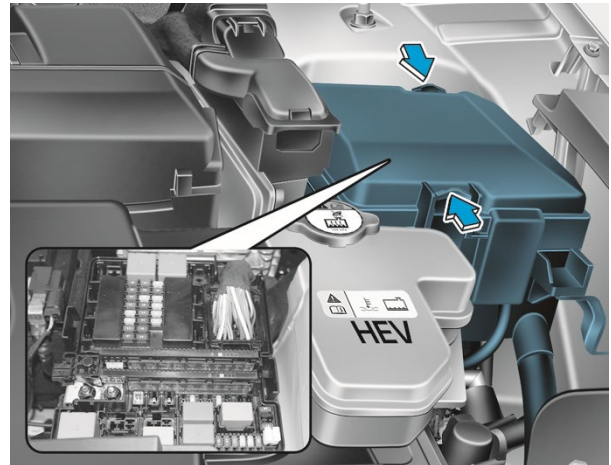

Engine room fuse box

4. Separate the negative(-) 12 Volt battery cable(B) located in the trunk to further prevent the risk of accidental restart.

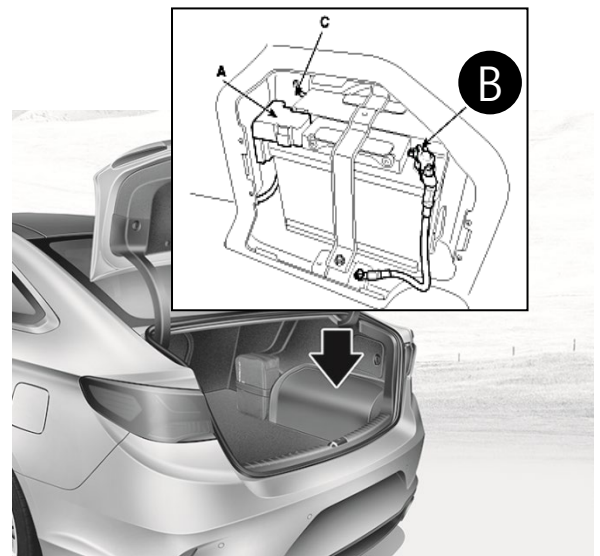

### 3. Disable direct hazards / safety regulations

5. Use the following procedure to remove the Service Disconnect Plug and disable the high voltage battery:

a) Remove the installation bolts (A), and then remove the safety plug cover (B).

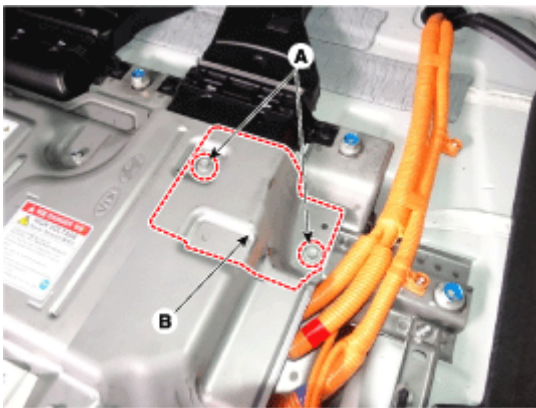

b) Remove the Service Disconnect Plug (C) using the following procedure :

A: Unlock → B: Release → C: Remove

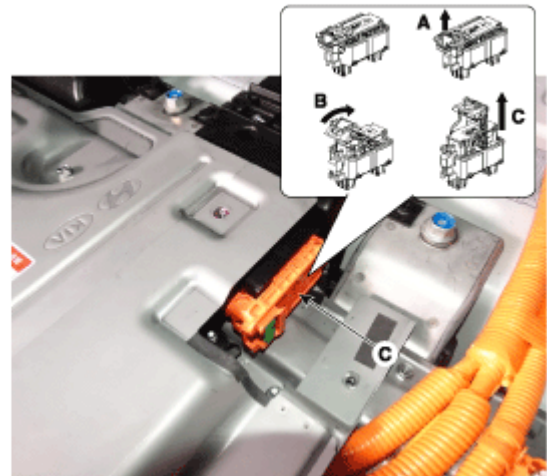

If both methods of disabling system are unsuccessful, the vehicle is not secured from accidental deployment of airbags and electric shock from high-voltage components.

#### **CAUTION** Electrocutation Risk

- *If necessary, lower the windows, unlock the doors and open the trunk as required, before disconnecting the 12 Volt battery. Once the 12 Volt battery is disconnected, power controls will not operate.*
- *Before engaging in any emergency response procedures, ensure the vehicle is disabled and wait 5 minutes to allow the capacitor in the high voltage system to discharge to avoid electrocution.*
- *Exposed cables or wires may be visible inside or outside the vehicle. Never touch the metal chassis wires, cables, connectors, or any electric components before disabling the system, and/or shorted to the vehicle chassis.*

*Failure to follow these instructions will lead to serious bodily injury or death by electrocution.*

## 4. Access to the occupants

### 4.1 Extraction Operations

The SONATA is a Hybrid model. Because of the high voltage components contained therein, first responders should exercise extreme caution when they extract occupants in the car.

Before performing any extraction operations, the first responders should "Identify, Immobilize and Disable" the vehicle as discussed in sections on emergency procedures.

### 4.2 Vehicle Stabilization

Use standard stabilization (lift) points, as shown to the right. Always be sure to connect to a structural member of the vehicle and avoid placing cribbing under high voltage cables, and other areas not normally considered acceptable.



### 4.3 Extraction tools and procedure

When responding to an incident involving a SONATA PHEV, we recommend that the first responders follow their organization's standard operating procedures for dealing with vehicle emergencies.

When the first responders cut the vehicle, they should always pay special attention to the airbag system, orange colored high voltage cables and other high voltage components so that the parts are not damaged and to prevent a risk of electric shock or explosion..

## 4. Access to the occupants

### 4.4 Location of ultra-high strength steel

In these images, high strength steel is used in the areas colored in blue and ultra-high strength steel is used in the red colored areas. Depending on the tools used, ultra high strength steel can be challenging or extremely difficult to cut. If necessary, use a workaround technique.

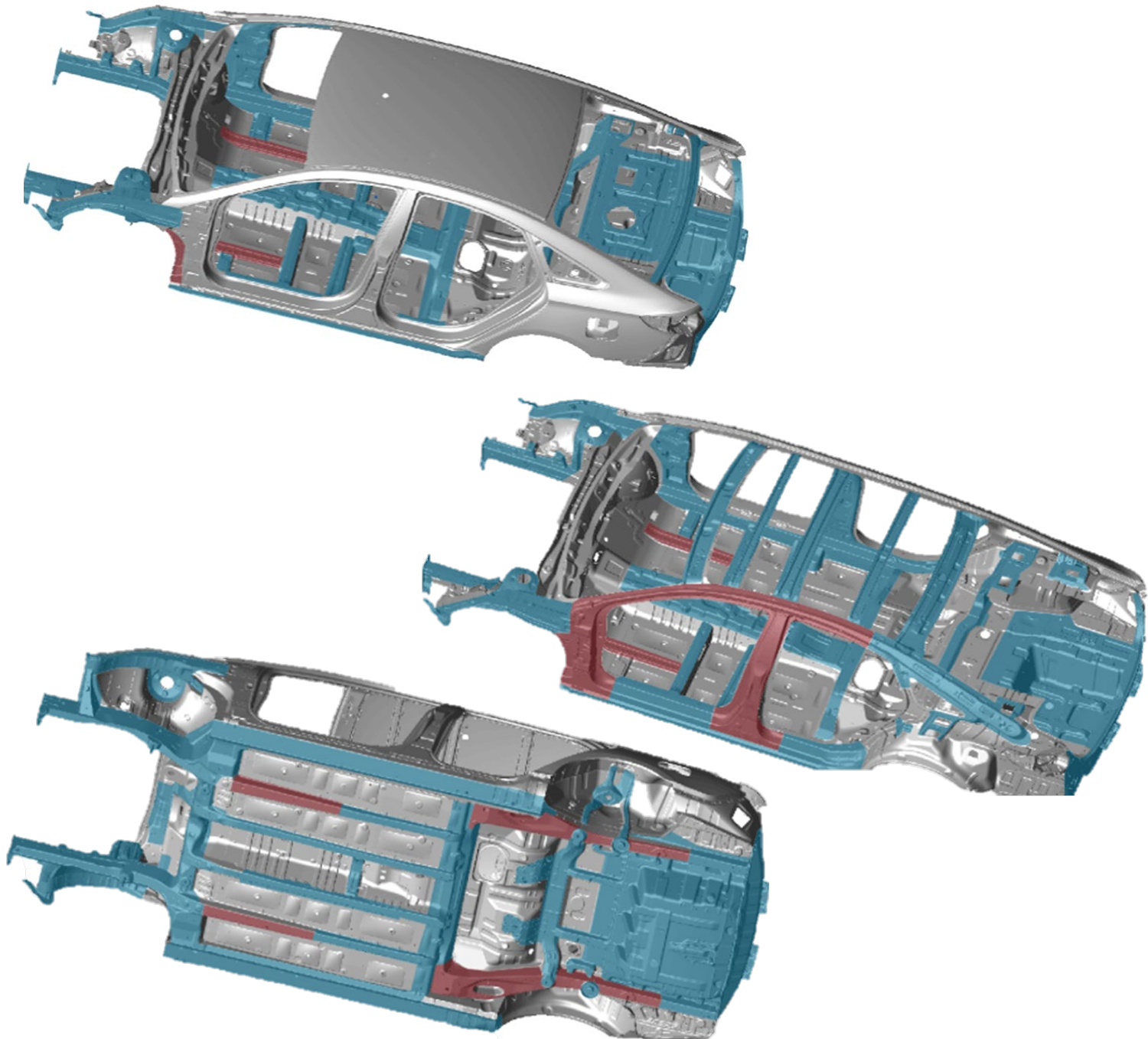









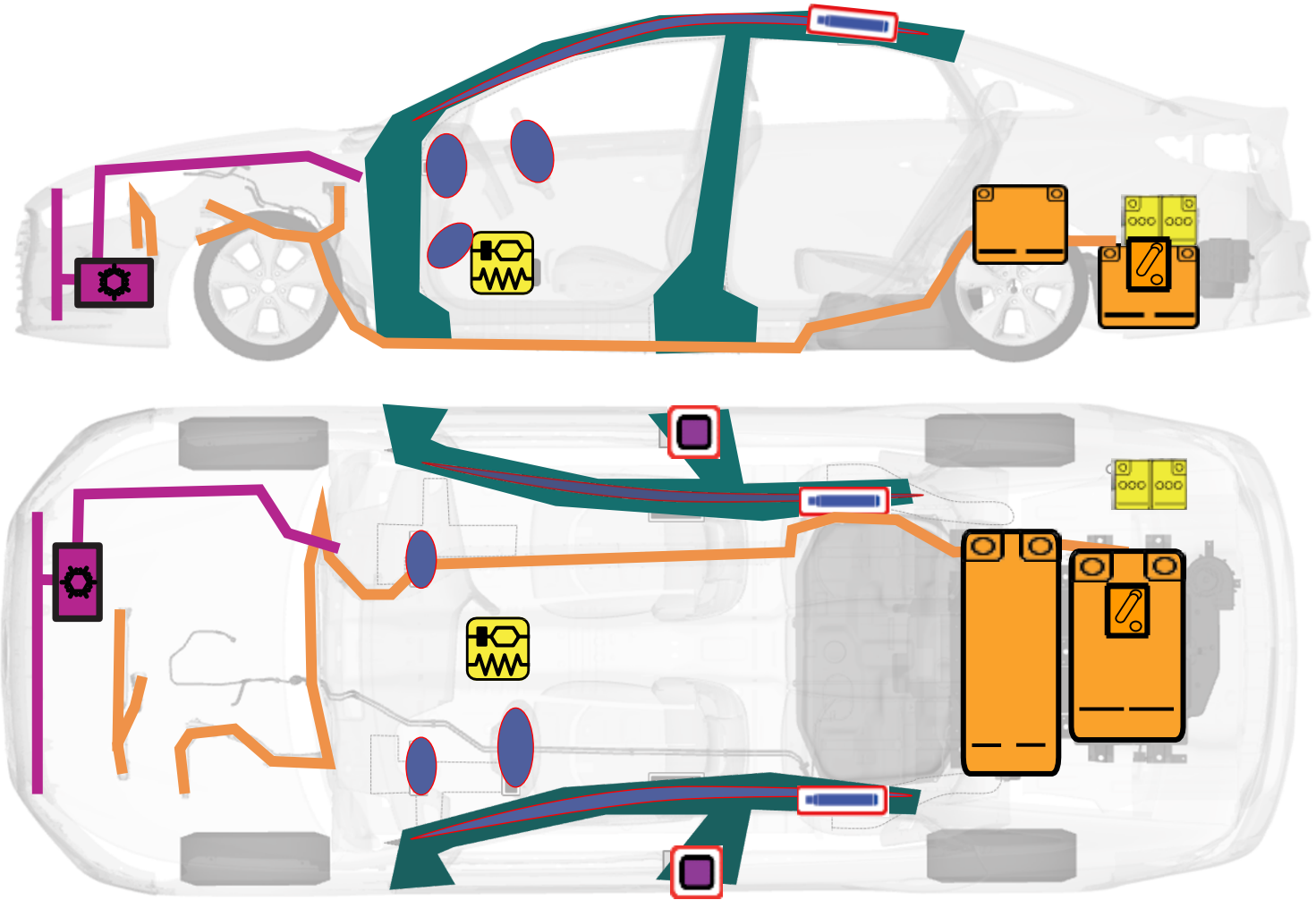



- Mild steel
- High strength steel
- Ultra-high strength steel

# 4. Access to the occupants

## 4.5 Occupants rescue guide

When dealing with an emergency situation, check the components as below.



 Supplemental Restraint System Control Module (SRSCM)	 Airbag	 Airbag Gas Inflators
 High voltage cable	 12 Volt Battery	 Air-conditioning line
 High Voltage Disconnect	 OBC (On – Board Charger)	 Ultra-High Strength Steel
 High Voltage Battery	 Air-conditioning component	 Seat belt pretensioner

## 5. Stored energy / liquid / gases / solids

### 5.1 High voltage system

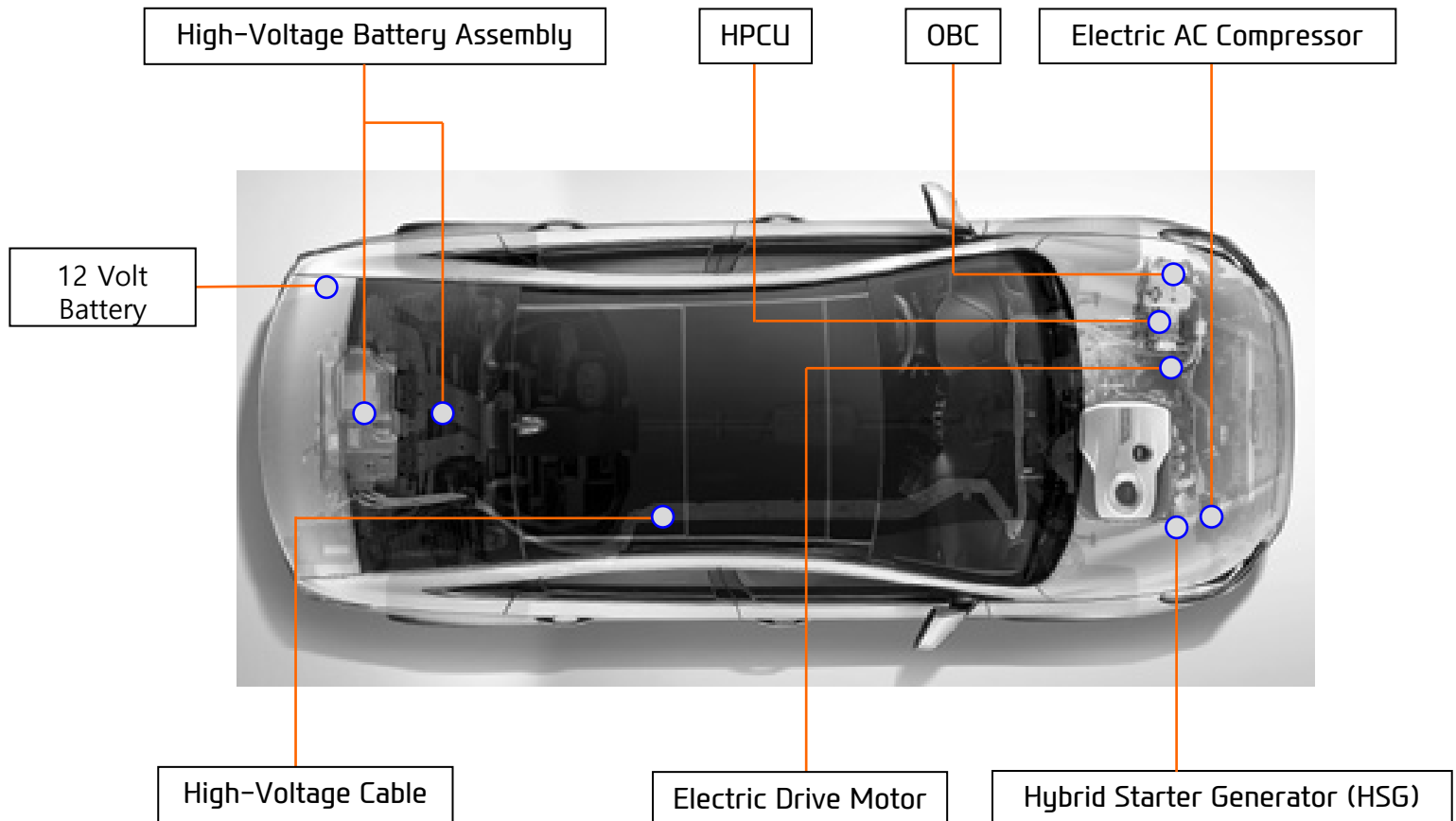

OBC	On-Board Charger : Battery charging equipment (AC → DC)
HPCU	Hybrid Power Control Unit (Inverter + LDC + HCU)
LDC	Low Power DC-DC Converter : Charge 12 Volt supplementary battery
Inverter	DC → AC (from battery to motor) AC → DC (charge using regenerative braking)
Motor	When current flows through the coil. It generates a rotating magnetic field and generates motor torque.
High voltage battery	Supplies and stores electric energy to traction motor.

## 5. Stored energy / liquid / gases / solids

### 5.1 High voltage system

#### High voltage battery

The High Voltage Lithium ion polymer battery supplies and stores electric energy, to the traction motor, and is located under the SONATA PHEV chassis.

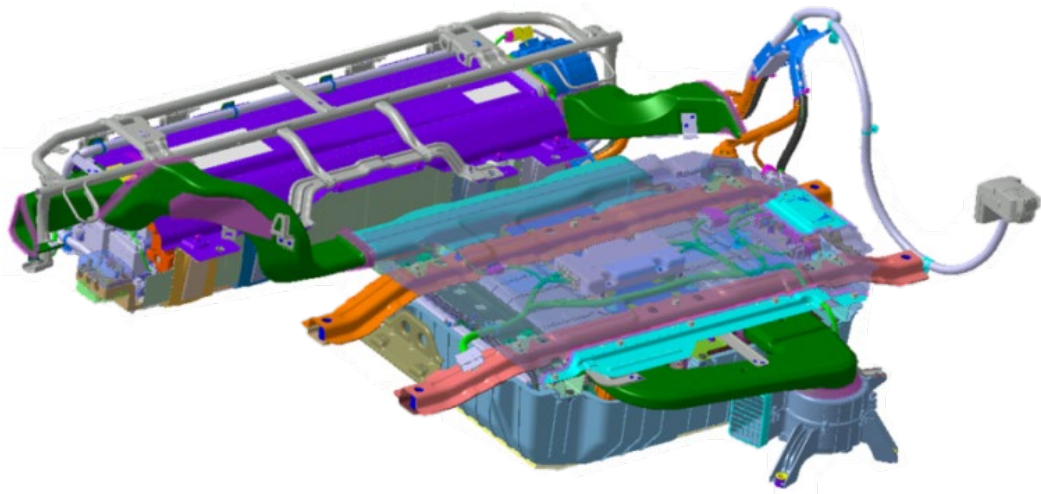

#### ※ Specification

<b>Motor</b>		Type	Permanent magnet synchronous motor
		Max. Output (kW)	44.5
		Max Torque (Nm)	170
<b>HPCU</b>	<b>Inverter</b>	Input Voltage(V)	240 – 410
	<b>LDC</b>	Max. Output (kW)	1.8
<b>High Voltage Battery</b>		Type	Lithium-ion polymer
		Rated Voltage (V)	360
		Energy (Wh)	8892
		Quantity for Pack (Cell / Module)	96 cells / 24 modules



## 5. Stored energy / liquid / gases / solids

### 5.2 High voltage orange cabling

The High Voltage cabling is orange, per Society of Automotive Engineers (SAE) standards. Cables run under the floor of the vehicle and connect the High Voltage Battery to the HPCU, Motor, LDC, Inverter, A/C compressor and other High Voltage components located towards the front of the vehicle.

The presence of orange cables under the hood, in the under-floor battery compartment, or High Voltage cables under the car, identifies the vehicle as an electric vehicle.

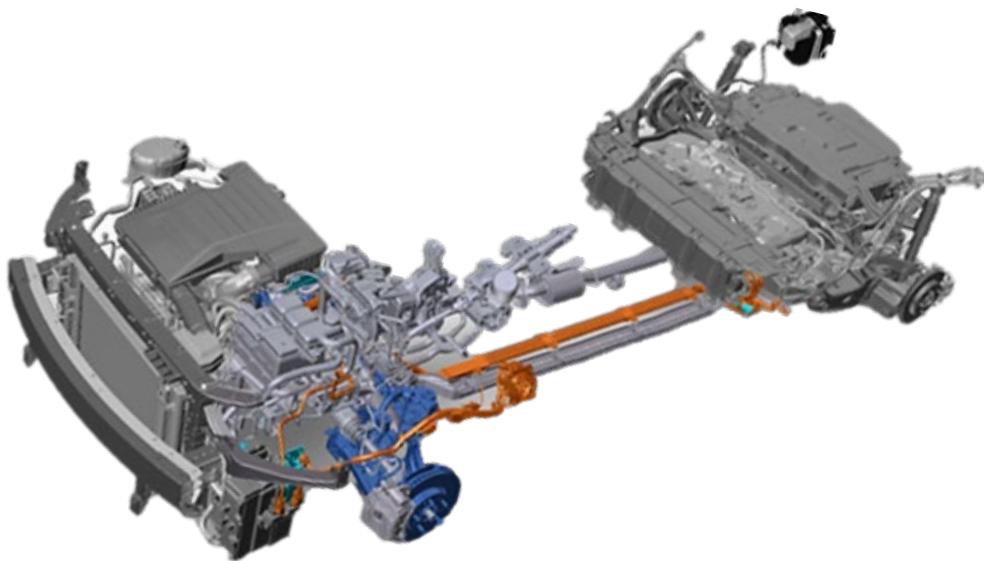

#### CAUTION

- *Never cut or disconnect the high voltage orange cabling and connectors without first disabling the High Voltage system (refer to page 7 ).*
- *Exposed cables or wires may be visible inside or outside the vehicle. Never touch the metal chassis wires, cables, connectors, or any electric components before disabling the system, and; or shorted to the vehicle chassis.*

*Failure to follow these instructions will lead to serious bodily injury or death by electrical shock.*

## 5. Stored energy / liquid / gases / solids

### 5.3 Fuel(Gasoline)

Sonata PHEV has a Gasoline engine. The fuel type is Gasoline stored in the fuel tank. When dealing with an emergency situation, be careful not to cut the fuel line and tank.

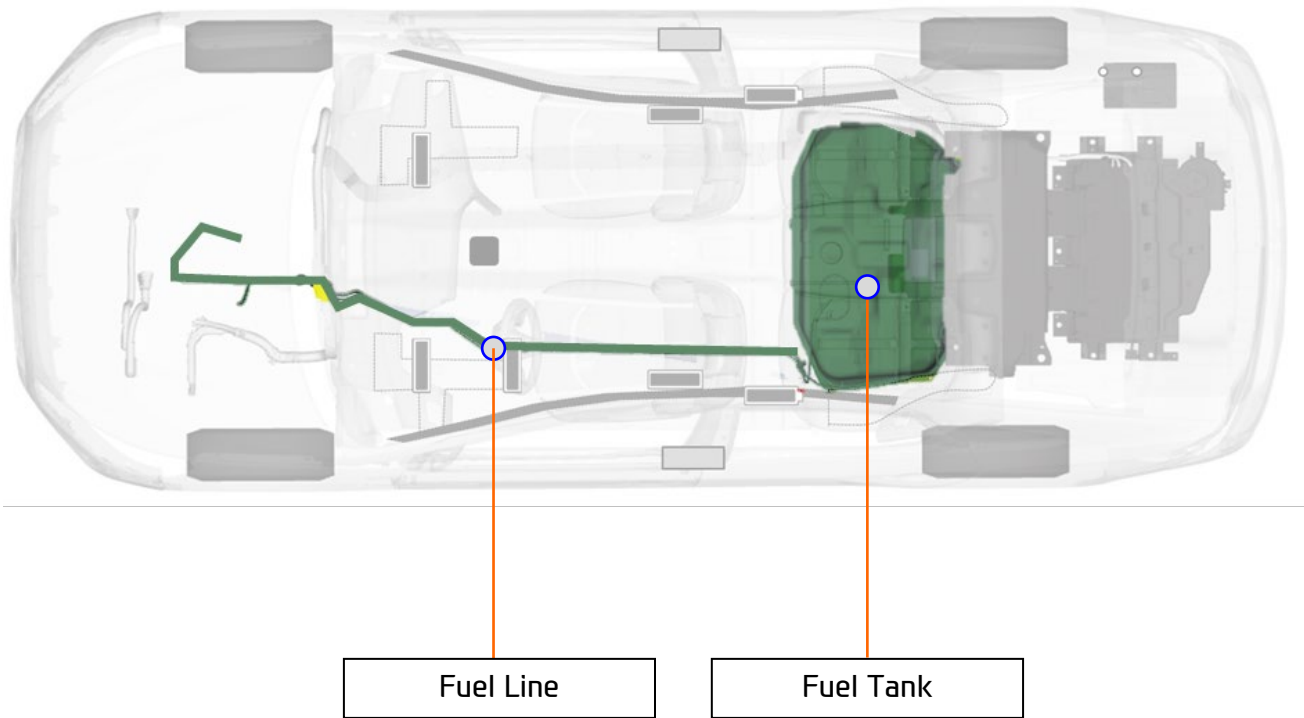

## 6. In case of fire

### 6.1 Firefighting Operations

Strict precautions must be taken while conducting firefighting operations due to following

Reasons:

- Lithium-ion Polymer batteries contain gel electrolyte that can vent, ignite, and produce sparks when subjected to temperatures above 300°F.
- Vehicle may burn rapidly with a flare-burning effect.
- Even after the high-voltage battery fire appears to have been extinguished, renewed or delayed fire can occur.
  - Use a thermal imaging camera to ensure the high voltage battery is completely cooled before leaving the incident.
  - Always advise fellow emergency responders and civilian that there is a risk of the battery re-igniting.
  - In a fire, submersion or a collision that has compromised the high voltage battery, store the vehicle in an open area with no exposure within 50 feet. Alternatively, a damaged vehicle or battery pack may be stored in a barrier of earth, steel, concrete, or solid masonry.
- A burning battery could release hydrogen fluoride, carbon monoxide, and carbon dioxide gasses. Use NIOSH/MSHA approved full-face self-contained breathing apparatus (SCBA) with full protective gear. Even if the high-voltage battery pack is not directly involved in a vehicle fire, approach the vehicle very carefully.

### 6.2 Extinguishers

- Small fires that do not involve the high voltage battery should be extinguished using an ABC fire extinguisher. (ex. Fire caused by wiring harnesses, electrical components, etc.)
- Do not attempt to extinguish fires that involve the high voltage battery with small amounts of water as this can result in electrocution. Fires that involve the high voltage battery should be extinguished using large amounts of water (minimum 2,650 gallons) to cool the high voltage battery. Fire fighters should not hesitate to pour larger amounts of water on the vehicle in such scenarios. Make sure the battery is fully cooled to avoid fire re-ignition.

## 6. In case of fire

### 6.3 How to deal with the situation

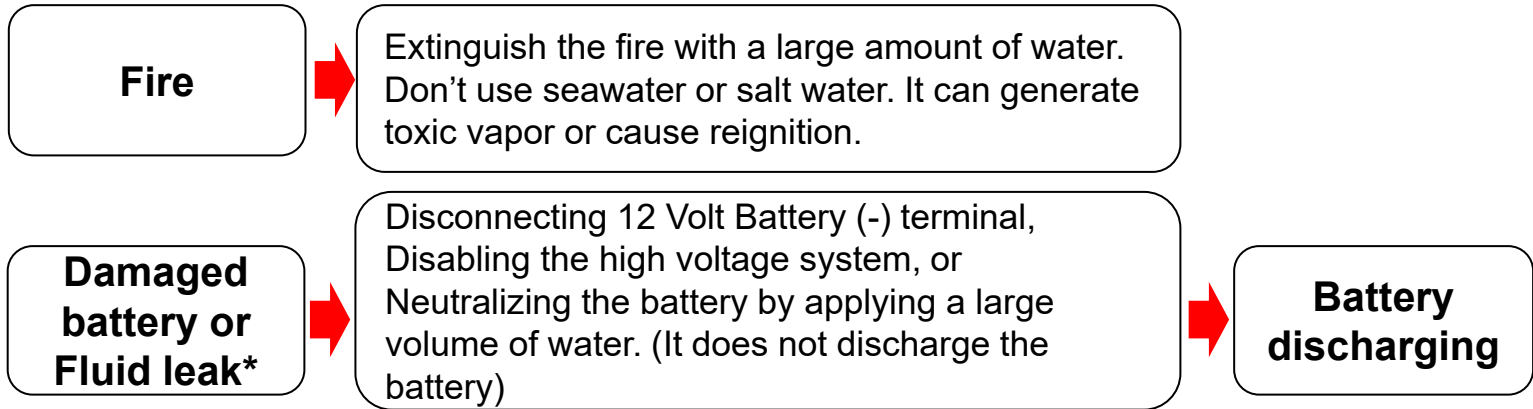

\*If electrolyte solution leakage, or any damage to the High Voltage battery casing is observed

#### 6.3.1 Vehicle fire

- Use a large volume of water (minimum 2,650 gallons). The water must cool down the battery.
- If water is put into the high voltage battery casing, it will be better to cool down the battery. (But never attempt to penetrate the HV battery or its casing to apply water.)



- Soaking the vehicle in the container filled with water can be an effective way to extinguish the fire.

## 6. In case of fire

### 6.3.2 High Voltage Battery Damage and Fluid Leaks

If electrolyte solution leakage, or any damage to the Lithium ion battery casing is observed, the first responders should attempt to neutralize the battery by applying a large volume of water to the battery pack while wearing appropriate Personal Protective Equipment (PPE). The neutralization process helps stabilize the thermal condition of the battery pack but does not discharge the battery.

- Do not put any smoke, spark or flame around the vehicle.
- Do not touch or step on the spilled electrolyte solution.
- If electrolyte solution leak occurs, wear appropriate solvent resistant PPE and use soil, sand, or a dry cloth to clean up the spill. Be sure to adequately ventilate the area.

#### **CAUTION** Electrolyte Irritation

*The high voltage battery contains electrolyte solution. To avoid exposure to electrolyte solution and serious personal injury, always wear appropriate solvent resistant PPE (Personal Protective Equipment) and SCBA (Self-Contained Breathing Apparatus).*

- *Electrolyte solution is an eye irritant – In the event of contact with eyes, rinse with plenty of water for 15 minutes.*
- *Electrolyte solution is a skin irritant. Therefore, in the event of contact with skin, wash off with a soap.*
- *Electrolyte liquid or fumes coming into contact with water will create vapors in the air from oxidization. These vapors may irritate skin and eyes. In the event of contact with vapors, rinse with plenty of water and consult a doctor immediately.*
- *Electrolyte fumes (when inhaled) can cause respiratory irritation and acute intoxication. Inhale fresh air and wash mouth with water. Consult a doctor immediately.*

## 6. In case of fire

### 6.4 High Voltage Battery re-ignition by stranded energy

Damaged cells in the high voltage battery can experience thermal runaway\* and reignition. To prevent reignition, responding emergency personnel need to be aware of the risk of stranded energy\* which remains in the damaged cells and lead to reignition.

\*Thermal runaway : The originating cause of thermal runaway is generally short-circuiting inside a battery cell and a resulting increase in the cell's internal temperature.

Battery produces heat with thermal runaway and it can spread from one battery cell to many cells, in a domino effect.

\*Stranded energy : Energy remains inside any undamaged battery cells after the accident. That stranded energy can cause a high voltage battery to reignite multiple times after firefighters have extinguished the fire.

### How to prevent reignition (Mitigating stranded energy risk)

Use a thermal imaging camera to ensure the high voltage battery is completely cooled before leaving the incident.

Always advise second responders that there is a risk of the battery re-igniting.

1. 12 Volt battery terminal disconnection (To depower battery management system)

2. High voltage shut off

\*refer to page 6-10

3. Discharging the high voltage battery

\*refer to page 24-25

## 7. In case of submersion

### 7.1 Submerged or Partially Submerged Vehicles

Some emergency responses can involve a submerged vehicle. SONATA PHEV that is submerged does not have high-voltage components on the vehicle's body or framework. It is safe to touch the vehicle's body or framework if there is no severe damage to the vehicle, whether it is in water or on land.

In the event the vehicle is submerged or partially submerged, remove the vehicle from the water before attempting to disable the vehicle. Drain the water from the vehicle. Use one of the methods described in page 6-10 to disable the vehicle.

Then, discharge the battery by referring to page 24-25.

#### CAUTION

- *If severe damage causes high voltage components to become exposed, responders should take appropriate precautions and wear appropriate insulated personal protective equipment.*

Failure to follow these instructions can lead to death or serious injury by electrocution.

## 8. Towing / Transportation / storage

### 8.1 Towing and Transportation

In the event of an accident, the high voltage system must be disabled. The safety plug must be removed from the high voltage battery according to one of the methods described in page 6-10 to disable the vehicle.

Towing the SONATA PHEV Vehicle is not different from towing a conventional electric vehicle.

If emergency towing is necessary, we recommend having it done by an authorized Hyundai dealer or a commercial tow-truck service. Proper lifting and towing procedures are necessary to prevent damage to the vehicle.

The use of wheel dollies or flatbed is recommended.

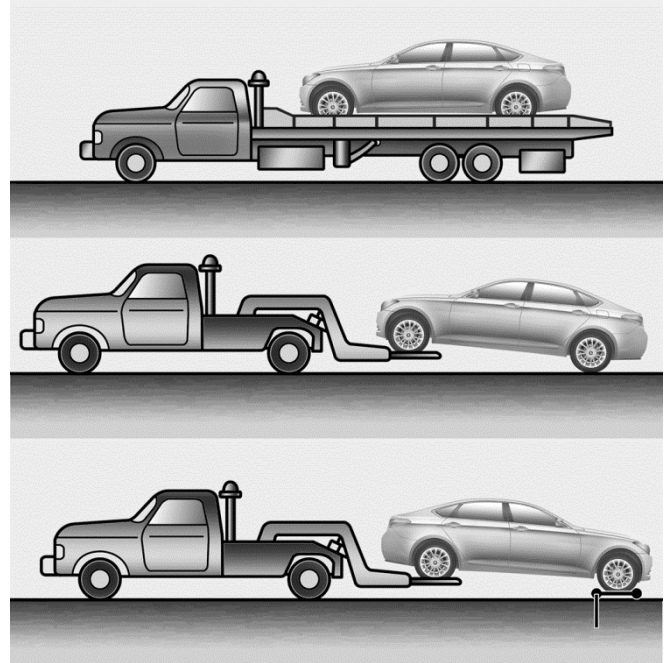

#### CAUTION

- *Do not tow with sling-type equipment. Use wheel lift or flatbed equipment.*
- *Never tow the vehicle with the front wheels on the ground (forward or backward), as this may cause fire or damage to the motor.*

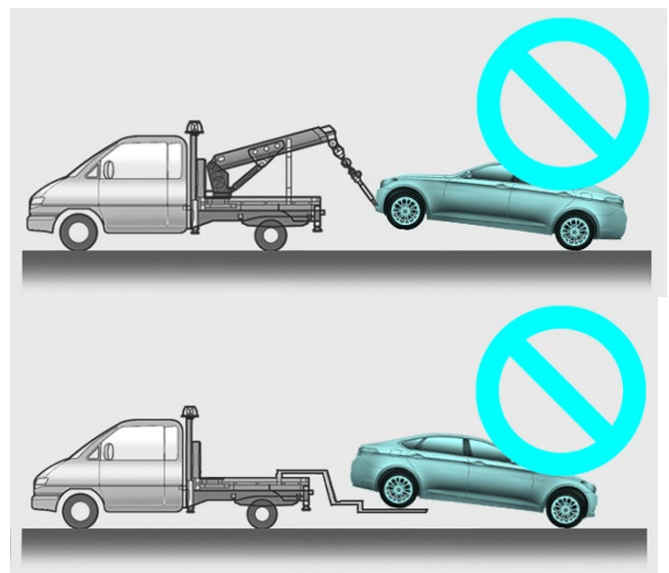



## 8. Towing / Transportation / storage

### 8.2 Storage of damaged vehicle with the damaged battery

- Drain fluids and water, then disconnect the negative(-) terminal of the 12 V battery before storing a damaged vehicle.
- In addition, remove the water inside the battery or vehicle, then remove the service plug before storing a damaged vehicle.
- Place the vehicle in an open space away from any structure, vehicle, or building.
- Then, keep on eye on the vehicle until the discharging procedures are completed.
- If the battery can be removed from the vehicle by moving the vehicle on a lift, remove and discharge the battery.
- If the battery can't be removed, set the water pool and pouring water until the entire battery is submerged.

# Water pool condition : tap water or pond water that does not contain salt

- Maintain this water level for at least 90 hours.
- Put salt into the water pool to make 3.5% salt water.
- Wait for additional 48 hours in salt water.
- Then, drain the water and dry it.

#### CAUTION

- *DO NOT USE SALT WATER FOR THE FIRST STEP.*
- *A large volume of flammable gas can be generated in salt water due to electrolysis.*
- *After submerging the vehicle in pure water for at least 90hours, put salt in the water pool.*



**Battery discharging**

## 8. Towing / Transportation / storage

### 8.3 Battery Storage

- To store the damaged battery safely, the battery must be discharged.
- If the battery can be removed from the vehicle, discharge the battery to prevent re-ignition.

#### CAUTION

- *Extinguish all smoke, spark, flame around the vehicle.*
  - *Electrolyte solution is an eye and skin irritant, so exercise caution..*
  - *Do not touch or step on the spilled electrolyte.*
  - *If electrolyte leak occurs, wear appropriate solvent resistant PPE and use soil, sand, or a dry cloth to clean up the spilled electrolyte. Be sure to adequately ventilate the area.*
- Prepare water that does not contain salt such as tap or pond water.
  - Leave the battery in water for at least 90 hours.
  - Then put salt into the water pool to make 3.5% salt water.
  - Wait for additional 48 hours in salt water.
  - Then take out the battery from the water pool and drain and dry it.

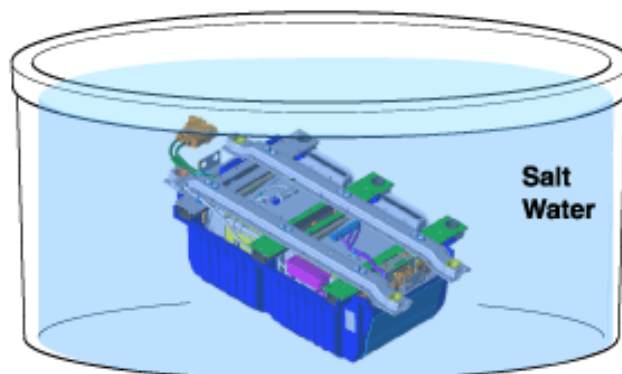
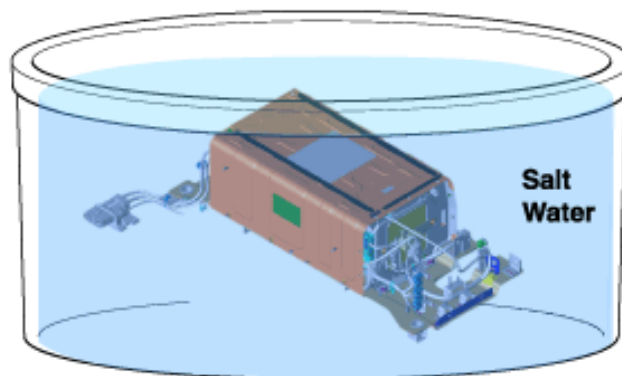

## 9. Important additional information

### 9.1 Emergency Starting

#### Jump Start the Car

1. Make sure the booster battery is 12-volt.
2. If the booster battery is in another vehicle, do not allow the vehicles to touch.
3. Turn off all unnecessary electrical loads.
4. First connect one end of a jumper cable to the positive terminal of the discharged battery in the engine compartment, then connect the other end to the positive terminal on the booster battery.

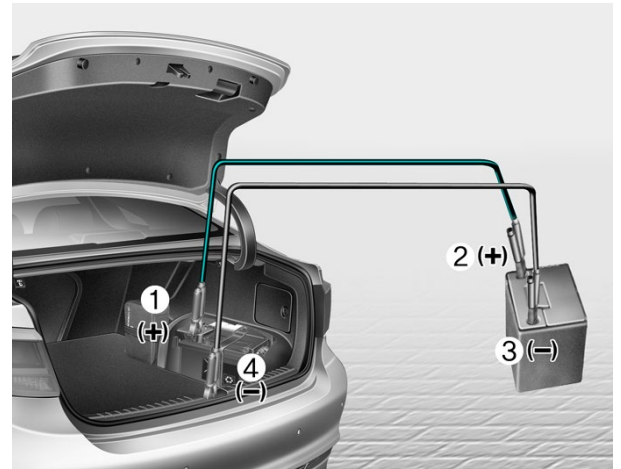

- Proceed to connect one end of the other jumper cable to the negative terminal of the booster battery, then the other end to a solid, stationary, metallic point away from the battery (for example, the latch).
5. Start the vehicle with the booster battery, then start the vehicle with the discharged battery.
  6. After a few minutes, turn off both of the vehicles.
  7. Remove the negative terminal cable first, and then remove the positive terminal cable. If the cause of your battery discharging is not apparent; we recommend that the system be checked by an authorized HYUNDAI dealer.

#### **CAUTION**

- Do not connect the cables to or near any part that moves when the vehicle is started.
- Do not allow the jumper cables to contact anything except the correct battery terminals or the correct ground.
- Do not lean over the battery when making connections.
- **Do not jump start another vehicle with hybrid vehicle. Jump starting another vehicle will damage the hybrid vehicle's 12 Volt battery (Lithium Polymer type).**

## 9. Important additional information

### 9.2 Airbag system (SRS: Supplemental Restraint System)

#### Airbag

Six airbags are installed in the SONATA PHEV, located in the areas shown in the image below. Before performing any emergency procedure, make sure the vehicle ignition switch is turned off and disconnect the 12 Volt auxiliary battery (located in the left side motor compartment) to prevent accidental deployment of the airbags.

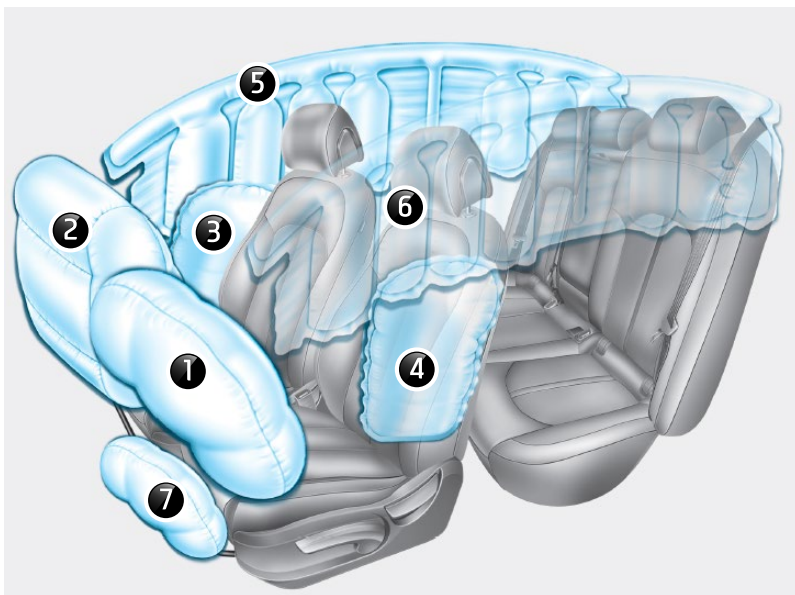

- (1) Driver front airbag
- (2) Passenger front airbag
- (3) Driver Side airbag
- (4) Passenger Side airbag
- (5) Passenger Curtain airbag
- (6) Driver Curtain airbag
- (7) Knee Airbag

\* The actual air bags and seats in the vehicle may differ from the illustration.

#### Seat Belt Pretensioner

In the SONATA PHEV, the driver's and front passenger's seat belts are equipped with pretensioners. When the seat belt pretensioners are activated in a collision, a loud noise may be heard and fine dust, which may appear to be smoke, may be visible in the passenger compartment. These are normal operating conditions and are not hazardous. The seat belt pretensioner assembly mechanisms may become hot during activation and may need several minutes to cool down after they have been activated.

## 9. Important additional information

### Airbag system components

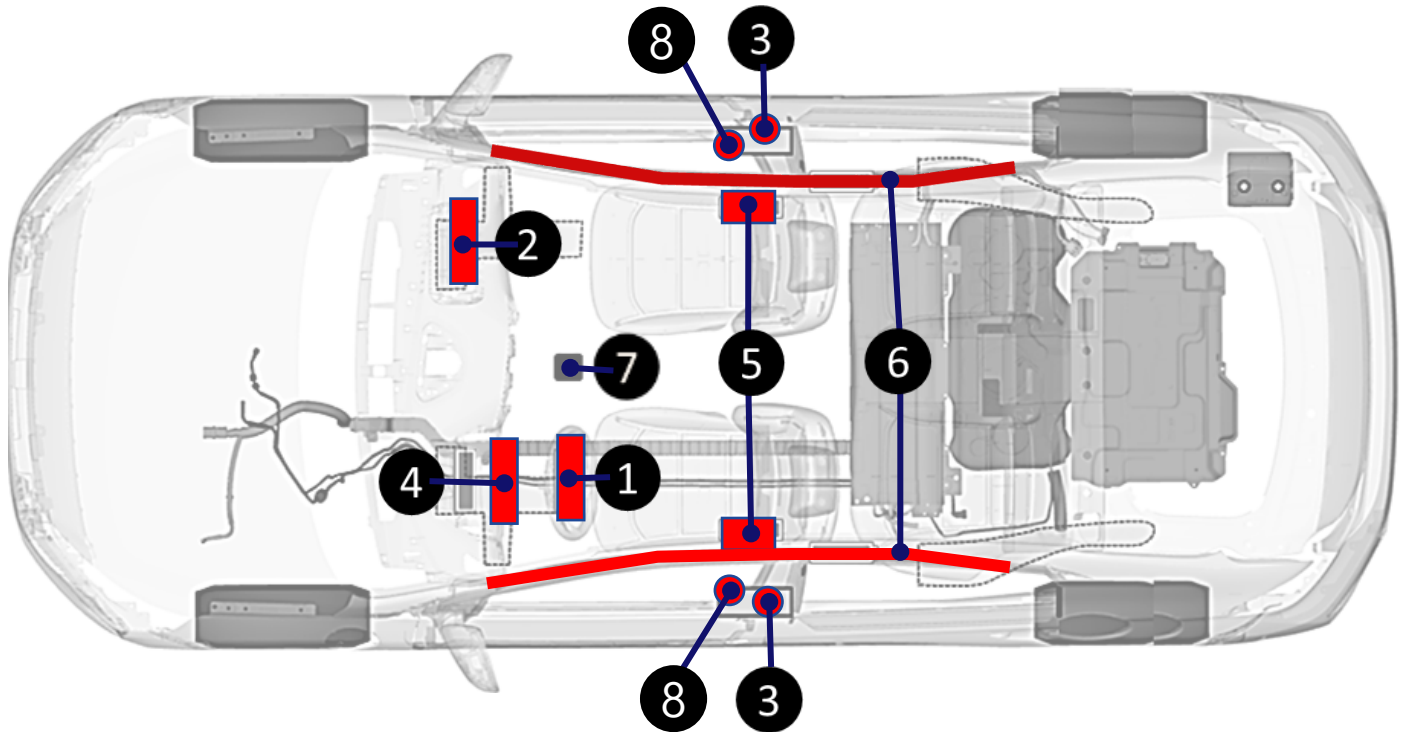

- 1. Driver's front airbag
- 2. Passenger's front airbag
- 3. Seat Belt Pretensioner (FBPT)
- 4. Knee Airbag
- 5. Side Airbag (Driver, Passenger side)
- 6. Curtain Airbag (Driver, Passenger side)
- 7. Supplemental Restraint System Control Module (SRSCM)
- 8. Emergency Fastening Device (EFD)

## 9. Important additional information

### Seat belt System

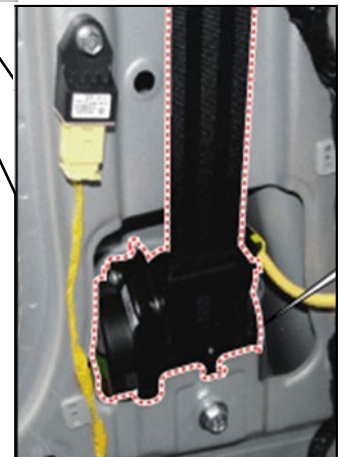

1. Front Seatbelt Pretensioner

#### **CAUTION Undeployed Airbags**

*To avoid injuries caused by accidental deployment of undeployed airbags*

- *Do not cut the red colored part shown in the image above.*
- *Make sure the vehicle ignition switch is turned off, disconnect the 12 Volt auxiliary battery (located in the left side of engine room) and wait 3 minutes or longer to allow the system to deactivate.*

*Failure to follow any of these instructions may result in serious injury or death from accidental deployment of the airbag system.*

